



Yuasa Technical Data Sheet

Yuasa M27-90S - Marine Batteries

Performance

Voltage	12V
Capacity (20-hour)	90Ah
Cold Cranking Amps (EN1)	720A

Dimensions

Length	304mm
Width	173mm
Height	225mm

Weights & Measures

Mean Weight with Acid	21.2kg
Dry Weight	-
Acid Volume	-



Container Features

Case Type	GR27 BCI
Cell Layout	1
Hold Down	B1
State of Charge Indicator	✓
Handles	✓
End Venting	✓
Semi-Traction Features	✓
Lid Type	SMF Double Lid

Technology

Flame Arrestor	✓
Technology	Ca/Ca
Separator	PE
VDA Roll Over Test	-
Recommended Charge Rate	5A

Terminal Type

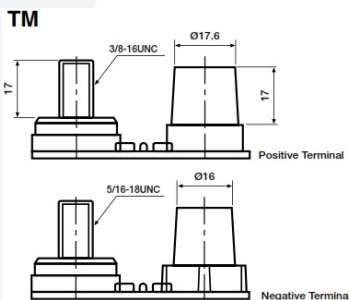

Cell Assembly Layout

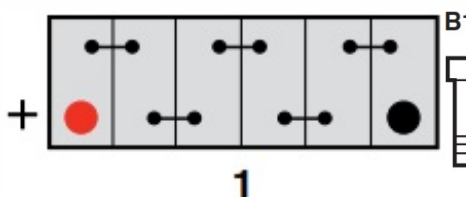

Battery Hold-down

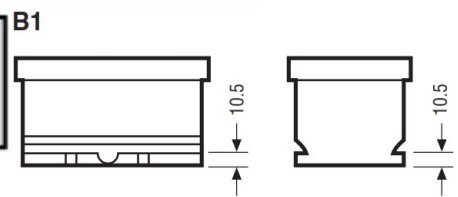

Data Sheet generated on 10/04/2019 - E&OE