

Powered by



XHRL12360W ▶ 12V 360W

XHRL 12360W is specially designed for high efficient discharge and long life application. Its characteristics are high energy density , small footprint and high discharge efficiency. It can be used for more than 260 cycles at 100% discharge in cycle service, up to 10 years in standby service.



► Specification

Cells per unit	6
Voltage per unit	12
Capacity	360W @15 min-rate to 1.67V per cell @25°C (77°F)
Weight	Approx. 27.5 kg (60.63 lbs)
Maximum Discharge Current	800A(5sec)
Internal Resistance	Approx. 4mΩ
Operating Temperature Range	Discharge: -20°C~50°C (-4°F~122°F) Charge: -20°C~50°C (-4°F~122°F) Storage: -15°C~40°C (5°F~104°F)
Nominal Operating Temperature Range	25°C ±3°C (77°F ±5°F)
Float Charging Voltage	13.5 to 13.8 VDC/unit Average at 25°C (77°F)
Recommended Maximum Charging Current Limit	36 A
Equalization and Cycle Service	14.4 to 15.0 VDC/unit Average at 25°C (77°F)
Self Discharge	CSB Batteries can be stored for more than 6 months at 25°C(77°F). Please charge batteries before using. For higher temperatures the time interval will be shorter.
Terminal	I2-Thread lead alloy recessed terminal to accept M6/M8 bolt
Container Material	Polypropylene(UL 94-HB) & Flammability resistance of (UL 94-V0) can be available upon request.



CSB-manufactured **VRLA** (Absorbent Glass Mat type) batteries are UL-recognized components under UL1989.

CSB is also certified by ISO 9001 and ISO 14001.

► Dimensions :

Unit: mm (inch)	Overall Height (H)	Container height (h)	Length (L)	Width (W)
	213.9±2.5 (8.42±0.10)	210.5±2.5 (8.29±0.10)	261.0±2.5 (10.28±0.10)	168.5±2 (6.64±0.08)

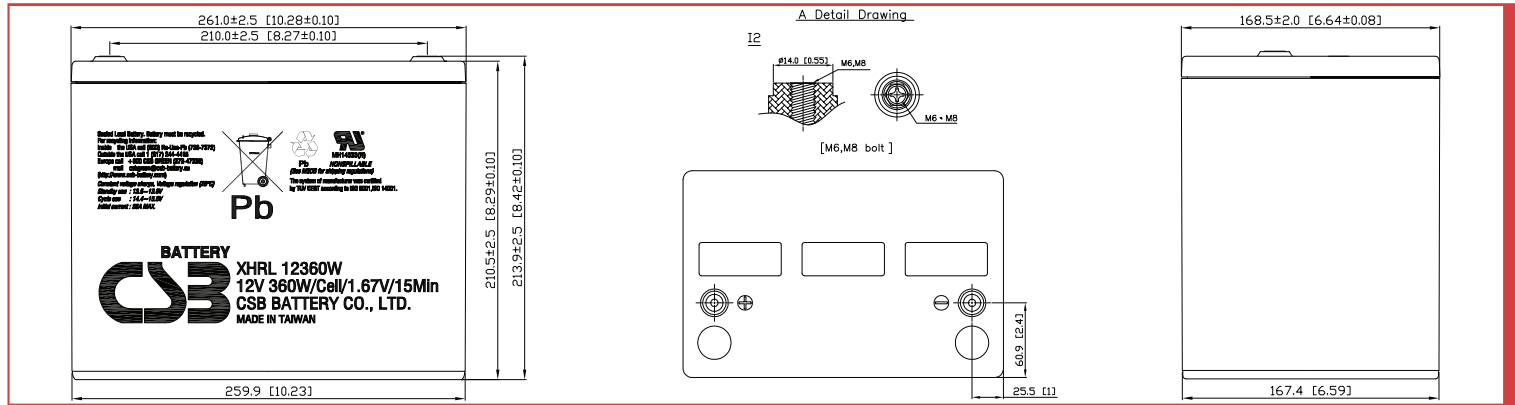

Constant Current Discharge Characteristics Unit:A (25°C, 77°F)

F.V/Time	2MIN	4MIN	6MIN	8MIN	10MIN	15MIN	20MIN	30MIN	60MIN	90MIN
1.60V	468	383	319	273	239	182	145	104	57.3	40.4
1.67V	405	352	300	257	228	176	142	102	56.9	40.3
1.70V	373	324	290	252	221	173	139	101	56.5	40.1
1.75V	347	299	267	234	210	165	133	98.4	55.4	39.4
1.80V	319	284	244	214	194	152	125	92.8	54.0	38.5
1.85V	281	238	208	192	174	139	115	86.9	50.3	34.7

Constant Power Discharge Characteristics Unit:W (25°C, 77°F)

F.V/Time	2MIN	4MIN	6MIN	8MIN	10MIN	15MIN	20MIN	30MIN	60MIN	90MIN
1.60V	4,544	3,982	3,529	3,081	2,758	2,198	1,735	1,232	678	485
1.67V	4,125	3,665	3,339	2,956	2,646	2,160	1,711	1,209	676	480
1.70V	3,850	3,516	3,203	2,830	2,530	2,080	1,664	1,184	668	477
1.75V	3,593	3,327	3,073	2,677	2,400	1,986	1,597	1,160	658	468
1.80V	3,376	3,020	2,777	2,476	2,240	1,858	1,514	1,102	644	459
1.85V	2,750	2,571	2,436	2,232	2,016	1,686	1,365	1,029	598	434

Ratings presented herein are subject to revision without notice. Please refer to www.csb-battery.com to confirm the latest version.

Trickle (or Float) Service Life

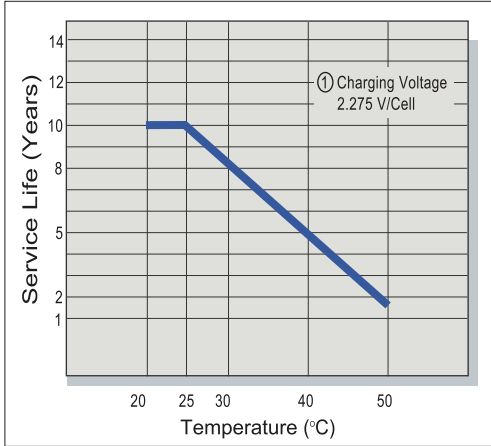

Capacity Retention Characteristic

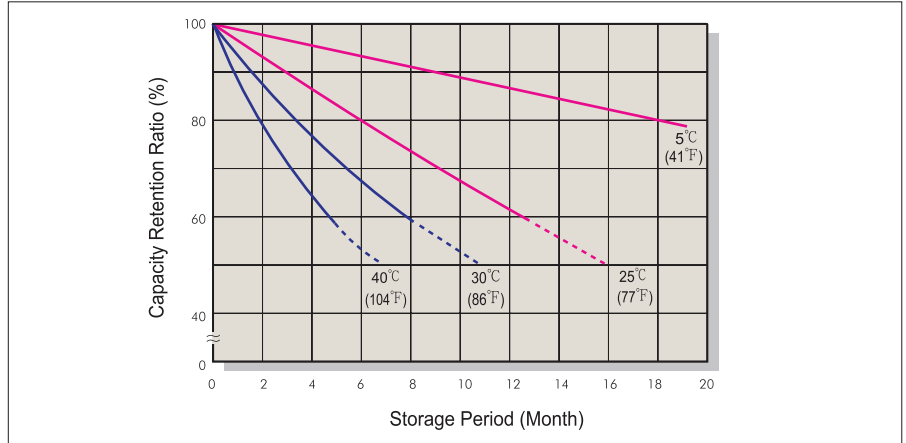

Battery Voltage and Charge Time for Standby Use

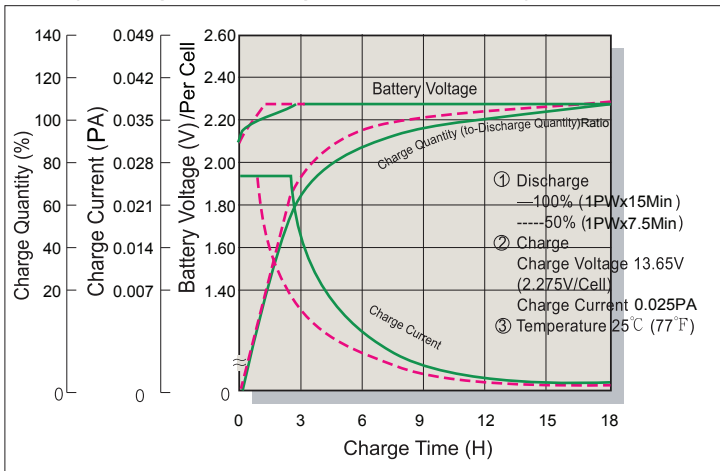

Cycle Service Life

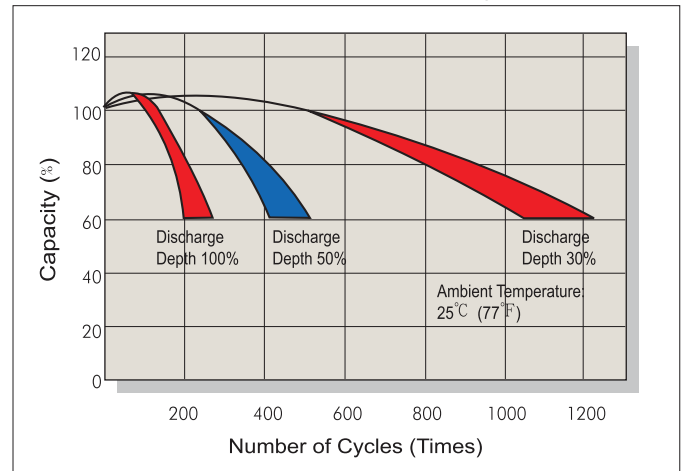

Battery Voltage and Charge Time for Cycle Use

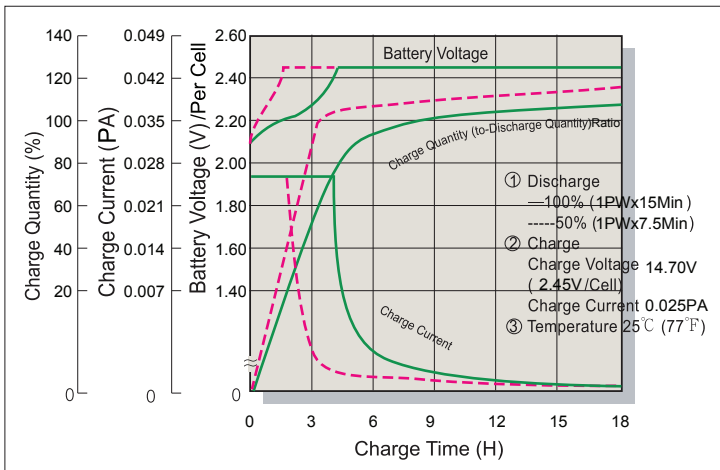

Terminal Voltage (V) and Discharge Time

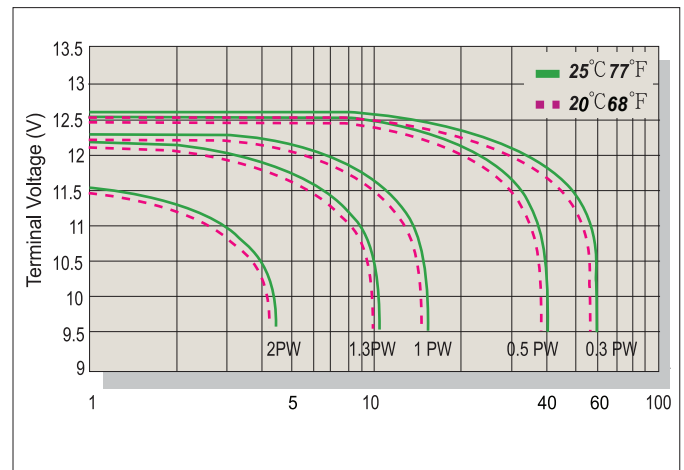

Charging Procedures

Application	Charge Voltage(V/Cell)			Max.Charge Current
	Temperature	Set Point	Allowable Range	
Cycle Use	25°C(77°F)	2.45	2.40~2.50	0.1PA
Standby	25°C(77°F)	2.275	2.25~2.30	

Discharge Current VS. Discharge Voltage

Final Discharge Voltage V/Cell	1.75	1.70	1.60	1.30
Discharge Power(W)	0.1P>(W)	0.1P≤(W)<0.25P	0.25P≤(W)<1.0P	(W)≥1.0P

Sales Office URL: WWW.CSB-BATTERY.COM

GLOBAL HQ
CSB BATTERY CO., LTD. (TAIWAN)
 Tel : +886-2-2880-5600
 Fax : +886-2-2888-3300
 mail : service@csb-battery.com.tw

BEIJING OFFICE. (CHINA)
CSB BATTERY TECHNOLOGIES (BEIJING) CO., LTD.
 Tel : +86-10-5820-5336/5338
 Fax : +86-10-58203053
 mail : chinasl@csb-battery.com

AMERICA HQ
CSB BATTERY TECHNOLOGIES INC. (U.S.A)
 Tel : +1-817-244-7777/1-(800)3-CSB-USA(272872)
 Fax : +1-817-244-4445
 mail : csb@csb-battery.com

SHANGHAI OFFICE. (CHINA)
CSB BATTERY LOGISTIC (SHANGHAI) CO., LTD.
 Tel : +86-21-5046-1622/5046-0833
 Fax : +86-21-5064-1046
 mail : chinasl@csb-battery.com

EUROPE HQ
CSB Battery Europe BV.
 Tel : +31(0)-180-418-140
 Fax : +31(0)-180-418-327
 mail : eurosales@csb-battery.eu

SHENZHEN OFFICE. (CHINA)
CSB BATTERY LOGISTIC (SHANGHAI) CO., LTD.
 Tel : +86-755-8831-6488/6396/6356
 Fax : +86-755-8831-6548
 mail : she@csb-battery.com.cn